

# RAC18-IP

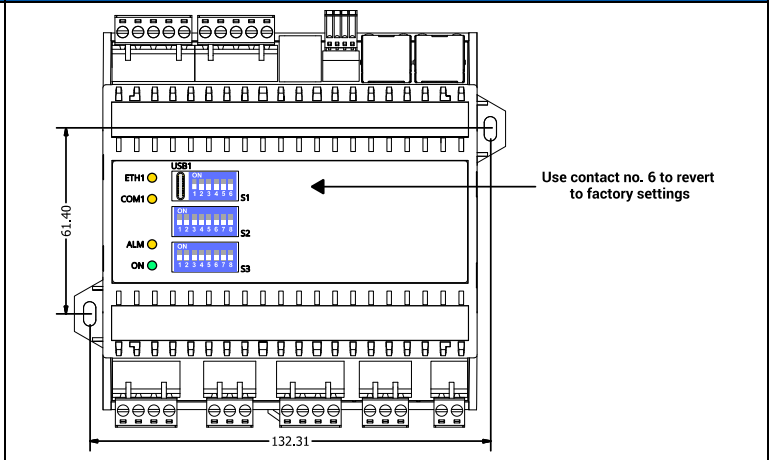

SPECIFICATION	
Power supply	DC: 24 V ± 20%, 10 W; AC: 24 V ± 20%, 23 VA
Vout	max. 5W, max. 40 V DC - depends on the input supply voltage 23 V DC for 24 V DC input supply voltage 33 V DC for 24 V AC input supply voltage
Universal inputs	4x voltage, current, resistance, temperature measurement, dry contact inputs
Digital inputs	4x dry contact inputs, high-speed pulse counter up to 100 Hz
Digital outputs	5x relay output; Resistive load max. 3 A @ 230 V AC, 3 A @ 30 V DC Inductive load max. 75 VA @ 230 V AC, 30 W @ 30 V DC
Analog outputs	3x 0-10 V DC output, maximum load up to 20 mA per channel
Triac outputs	2x 0,5 A; maximum voltage up to 230 V AC
Interfaces	2x Port 10/100 Ethernet Switch with failsafe protection; RS485; USB type C
Ingress protection	IP20 - for indoor installation
Temperature	Operating: 0°C to +50°C (32°F to 122°F) Storage -40°C to +85°C (-40°F to +185°F)
Relative humidity	5 to 95% RH (without condensation)
Connectors	RS485 connector: Separable, screwless max 1.5 mm <sup>2</sup> (24 ... 16 AWG) + RJ45 Other connectors: Separable max 2.5 mm <sup>2</sup> (18 ... 12 AWG)
Dimensions	123,5 x 137 x 55 mm (4,86 x 5,39 x 2,16 in)
Mounting	DIN rail mounting (DIN EN 50022 norm)
Housing material	Plastic, self-extinguishing PC/ABS

## BLOCK DIAGRAM DIMENSION / TOP PANEL

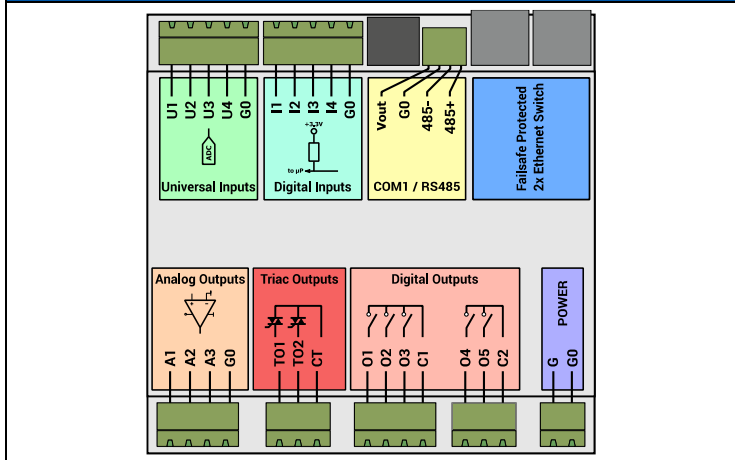

## UNIVERSAL INPUTS DIGITAL INPUTS

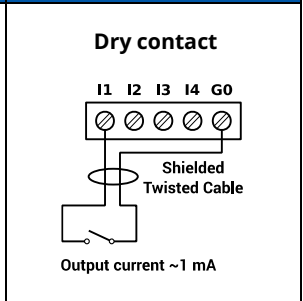
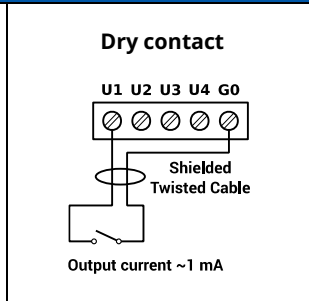
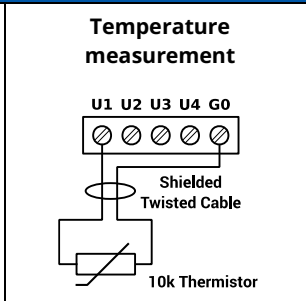
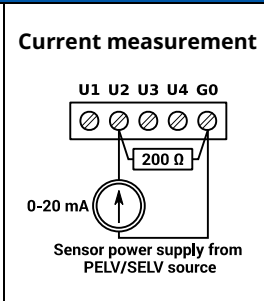
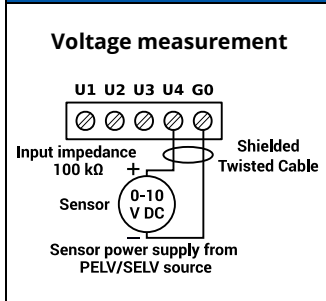

## DIGITAL OUTPUTS

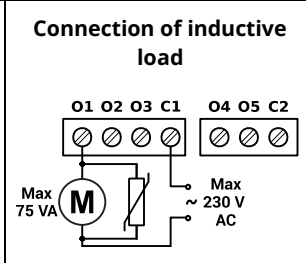
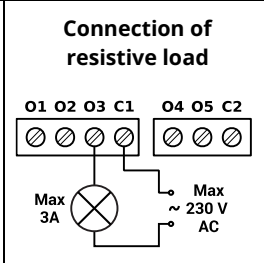
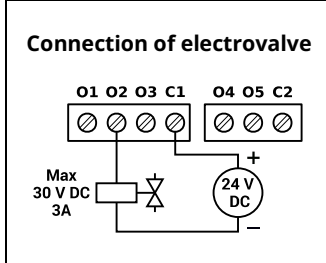

## TRIAC OUTPUTS

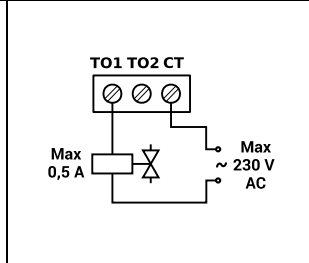

## POWER

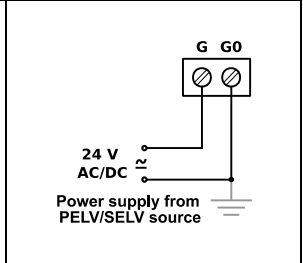

## ANALOG OUTPUTS

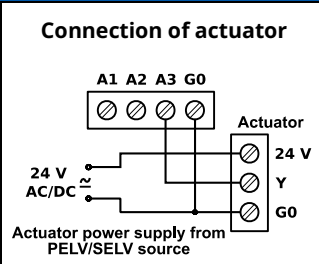
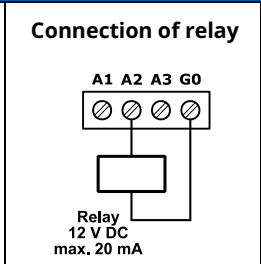
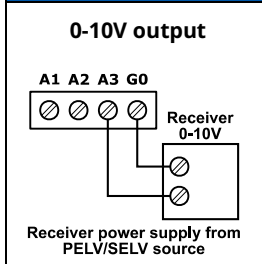

## COMMUNICATION

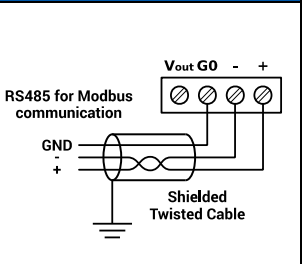
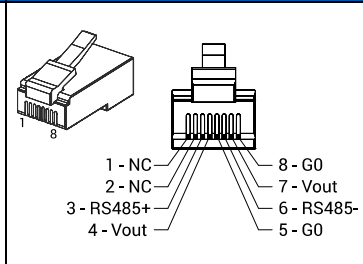

## RS485 CONFIGURATION

In the RAC18-IP device there is a built-in 3 position switch, which is dedicated to connect 120 Ω termination resistor and/or biasing resistors. It can be accessed by removing the top part of enclosure.

Switch Position	Biasing	Termination 120 Ω
1 (NONE) - default	OFF	OFF
2 (BIA)	ON	OFF
3 (END)	ON	ON

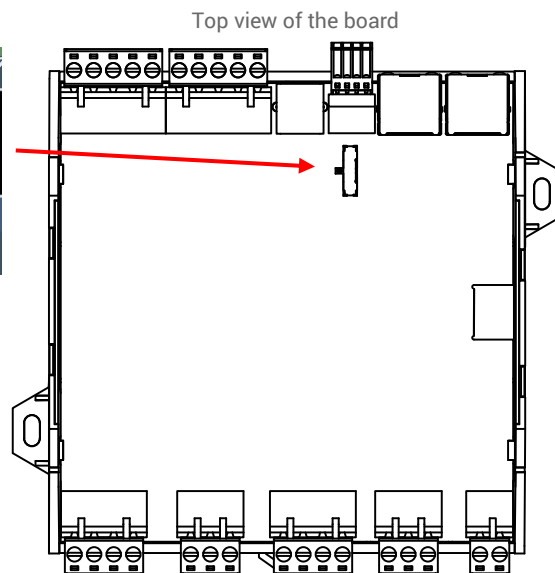
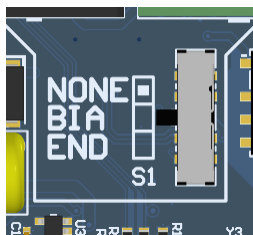

## FCC COMPLIANCE NOTE

Note: This equipment has been tested and found to comply with the limits for a Class B digital device, pursuant to part 15 of the FCC Rules. These limits are designed to provide reasonable protection against harmful interference in a residential installation. This equipment generates, uses and can radiate radio frequency energy and, if not installed and used in accordance with the instructions, may cause harmful interference to radio communications. However, there is no guarantee that interference will not occur in a particular installation. If this equipment does cause harmful interference to radio or television reception, which can be determined by turning the equipment off and on, the user is encouraged to try to correct the interference by one or more of the following measures:

- Reorient or relocate the receiving antenna.
- Increase the separation between the equipment and receiver.
- Connect the equipment into an outlet on a circuit different from that to which the receiver is connected.

Consult the dealer or an experienced radio/TV technician for help.



Please read the instruction before use or operating the device. In case of any questions after reading this document, please contact the iSMA CONTROLLI Support Team ([support@ismacontrolli.com](mailto:support@ismacontrolli.com)).



- Before wiring or removing/mounting the product, make sure to turn the power off. Failure to do so might cause an electric shock.
- Improper wiring of the product can damage it and lead to other hazards. Make sure that the product has been correctly wired before turning the power on.
- Do not touch electrically charged parts such as power terminals. Doing so might cause an electric shock.

• Do not disassemble the product. Doing so might cause an electric shock or faulty operation.



- Use the product only within the operating ranges recommended in the specification (temperature, humidity, voltage, shock, mounting direction, atmosphere, etc.). Failure to do so might cause a fire or faulty operation.

- Firmly tighten the wires to the terminal. Failure to do so might cause a fire.

- Avoid installing the product in close proximity to high-power electrical devices and cables, inductive loads, and switching devices. Proximity of such objects may cause an uncontrolled interference, resulting in an instable operation of the product.
- Proper arrangement of the power and signal cabling affects the operation of the entire control system. Avoid laying the power and signal wiring in parallel cable trays. It can cause interferences in monitored and control signals.
- It is recommended to power controllers/modules with AC/DC power suppliers. They provide better and more stable insulation for devices compared to AC/AC transformer systems, which transmit disturbances and transient phenomena like surges and bursts to devices. They also isolate products from inductive phenomena from other transformers and loads.
- Power supply systems for the product should be protected by external devices limiting overvoltage and effects of lightning discharges.
- Avoid powering the product and its controlled/monitored devices, especially high power and inductive loads, from a single power source. Powering devices from a single power source causes a risk of introducing disturbances from the loads to the control devices.
- If an AC/AC transformer is used to supply control devices, it is strongly recommended to use a maximum 100 VA Class 2 transformer to avoid unwanted inductive effects, which are dangerous for devices.
- Long monitoring and control lines may cause loops in connection with the shared power supply, causing disturbances in the operation of devices, including external communication. It is recommended to use galvanic separators.
- To protect signal and communication lines against external electromagnetic interferences, use properly grounded shielded cables and ferrite beads.
- Switching the digital output relays of large (exceeding specification) inductive loads can cause interference pulses to the electronics installed inside the product. Therefore, it is recommended to use external relays/contactors, etc. to switch such loads. The use of controllers with triac outputs also limits similar overvoltage phenomena.
- Many cases of disturbances and overvoltage in control systems are generated by switched, inductive loads supplied by alternating mains voltage (AC 120/230 V). If they do not have appropriate built-in noise reduction circuits, it is recommended to use external circuits such as snubbers, varistors, or protection diodes to limit these effects.



Electrical installation of this product must be done in accordance with national wiring codes and conform to local regulations.